

LEDko SHHH

Last update:
14/01/2025



LEDko SHHH with Front Barrel and Lens Tube

Introducing

● Designed with new electronics and OLED display, this product, a variant of the LEDko, has as its main feature the absence of the fan into the LED engine. It allows you to have all the functions of the LEDko but at the same time turns out to be a very silent product, suitable for any type of installation even where maximum silence and respect is required.

Key Features

- Fanless LED engine
- **T/D version:** Tungsten or Daylight COB LED
- **VW version:** VariWhite COB LED
- **FS version:** Red, Green, Blue, Cyan, Lime, Amber light source, 20 bit color mixing (Color mixing with hue and saturation control and Green-Magenta adjustment)
- CRI > 95
- **T/D version:** 3.200 K or 5.600 K
- **VW version:** from 2.700 K to 6.500 K
- **FS version:** from 2.700 K to 10.000 K (through DMX Chart) or up to 20.000 K (through Display)
- LED profile spot
- High Lumen flux and flat field
- Swappable lens tube between 5°-90°
- Soft profiling thanks to Fresnel and PC optics (Coemar patent)
- Four blade framing system, each shutter blade is adjustable for radial position and angle
- Custom color on request (optional)
- Manual Yoke
- European Conformity certification

General	
● LED Source	T/D version: Tungsten or Daylight COB LED VW version: VariWhite COB LED FS version: RGBCLA COB LED (Red, Green, Blue, Cyan, Lime, Amber) - Color mixing with hue and saturation control
● CCT Range	T/D version: ● 3.200 K (T) or ● 5.600 K (D) VW version: ● ● ● ● 2.700 K → 6.500 K FS version: ● ● ● ● 2.700 K → 20.000 K
● Color Rendition Average	CRI > 95, TLCI > 95
● Green-Magenta adjustment	Continuously adjustable from full minus-green to full plus-green
● Dimming	8 or 16 bit, 6 selectable curves: Exponential, Logarithmic, Linear, Halo, Standard and S
● Dimming Smooth Selection	Fast, Slow and Very Slow
● Strobe	Synchronized, random or pulse electronic strobe
● Available Optics	Swappable lens tubes between 5°-90°
● Camera flicker control/Hz range	T/D version: 600 → 20.000 Hz VW & FS version: 20.000 Hz
● Calibrated Cob	Yes
● L80 Rating (hours to 80% output)	50.000 Hours
● Pattern projection	Yes
● Pattern size	A or B
Electrical	
● Voltage Input	85-264 V, 50/60 Hz, auto-sensing
● Power Consumption	T/D version: 200 W Maximum - 0.92 A at 230, 1.83 A at 115V - cosφ 0.95 VW version: 220 W Maximum - 0.97 A at 230 V, 1.95 A at 115 V - cosφ: 0.98 FS version: 220 W Maximum - 1.06 A at 230 V, 2.13 A at 115 V - cosφ: 0.9
● Power Connection	In and Out PowerCON TRUE1 Top connectors, 1.5 m (4.9 ft) PowerCon cable without power plug
● Data Connection	In and Out DMX 5 pin locking XLR connectors
Thermal	
● Ambient Operating Temperature	0°C - +40°C (32°F - 104°F)
● Cooling	Fanless LED engine
Control	
● Protocols	DMX-512, RDM (Remote Device Management), Wireless (optional by LumenRadio)
● RDM Configuration	Yes
● DMX Channels	T/D version: 5 / 1 VW version: 5 / 2 / 1 / Sunrise / Raw / MK1 / 6 Channels FS version: 16 / 7 / 1 / Studio / RGB / Fine RGB / Sunrise Mode
● Display	Graphic OLED
● Firmware Upgrade	Through DMX with RDM Upgrade USB interface (code AC10011A001)
Physical	
● Mounting	Manual yoke
● Materials	Aluminum body
● Framing System	Four stainless steel shutter blades in a two-plane assembly, 0.40mm (AISI 316), each shutter blade is adjustable for radial position and angle
● Weight	12 Kg (26.45 lbs)
● IP Rating	IP20
● Color Options	Black (standard), custom color on request (optional)
Included accessories	
GKIT17 (USA) / GKIT16 (EU)	1.5 m power cable with PowerCON TRUE1 Top without power plug
BC10011A106	Metal Gobo Holder

Optics

BC10011A017	Profile Zoom 15°-35°
BC10011A019	Profile Zoom 25°-50°
BC10011A003	Profile Zoom 28°-40°
BC10011A002	Soft Profile Fresnel Zoom 14°-40°
BC10011A001	Soft Profile PC Zoom 11°-38°
BC10011A000	Front Barrel with Burnished Blades
BC10011A041	Lens Tube Profile 5°
BC10011A042	Lens Tube Profile 10°
BC10011A023	Lens Tube Profile 14°
BC10011A012	Lens Tube Profile 19°
BC10011A013	Lens Tube Profile 26°
BC10011A015	Lens Tube Profile 36°
BC10011A016	Lens Tube Profile 50°
BC10011A024	Lens Tube Profile 70°
BC10011A025	Lens Tube Profile 90°

General accessories

BC10034A003	4-Leaf Barndoor for Zoom Fresnel optic
BC10011A006	Magnetic Gobo Holder
BC10011A106	Metal Gobo Holder
BC10011A030	Gobo Holder for Glass Gobo
BC10011A010	Iris
BC10011A049	Gobo Holder for Iris Slot

Accessories for Profile Zoom

BC10011A028	Donut (190.5 mm)
BC10011A027	Half Top Hat (190.5 mm)
BC10011A029	Top Hat (190.5 mm)
BC10011A040	Color Frame Holder (190.5 mm)

Accessories for Soft Profile Zoom

BC10011A036	Donut (185 mm)
BC10011A035	Half Top Hat (185 mm)
BC10011A037	Top Hat (185 mm)
ACO4204	Color Frame Holder (185 mm)

Accessories for Lens Tube

BC10011A032	Donut (159 mm)
BC10011A031	Half Top Hat (159 mm)
BC10011A033	Top Hat (159 mm)
BC10011A021	Color Frame Holder (159 mm)

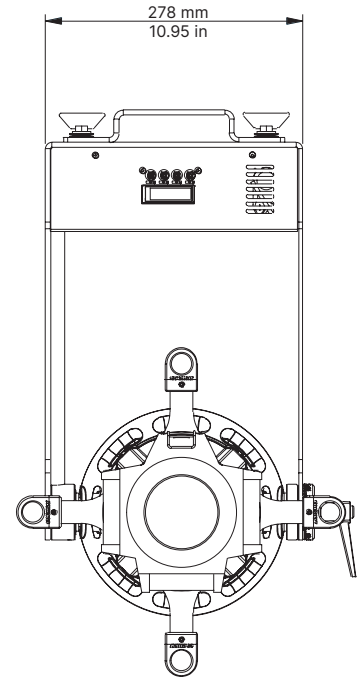
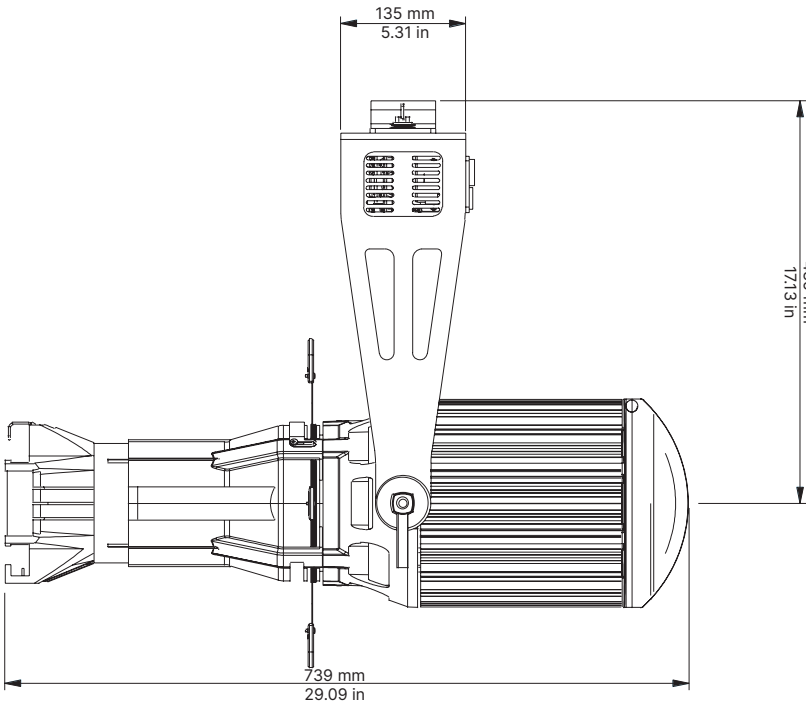
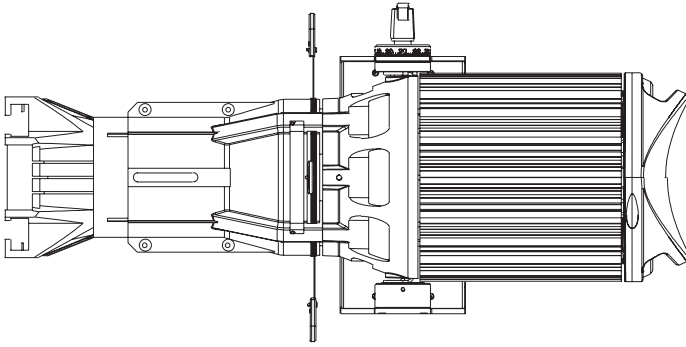

Drawing Size - Remote Power Supply Box

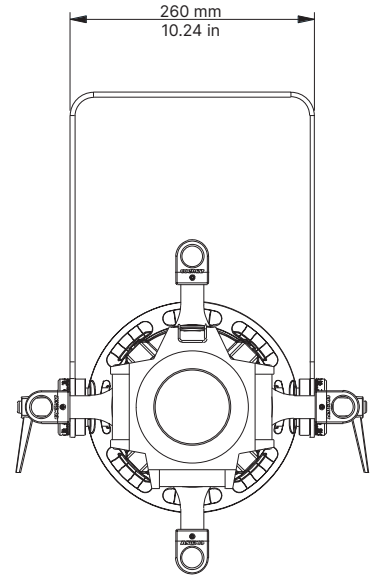
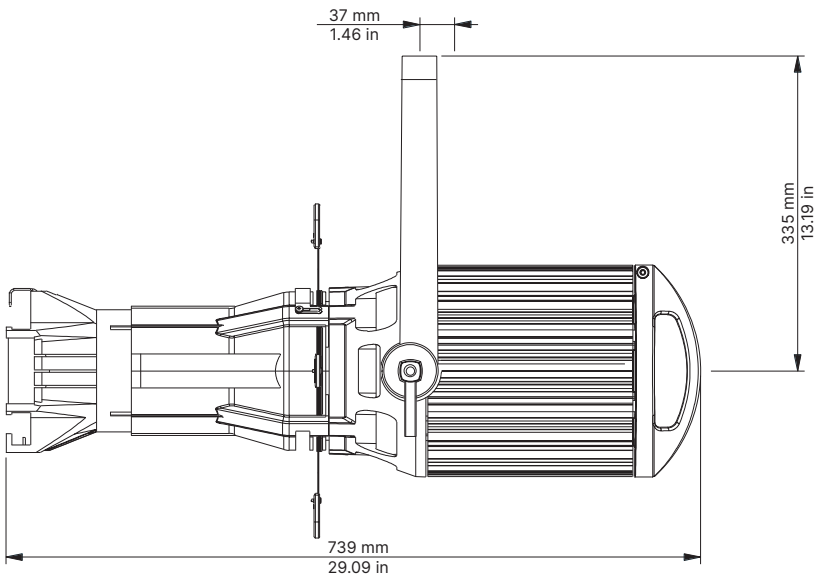
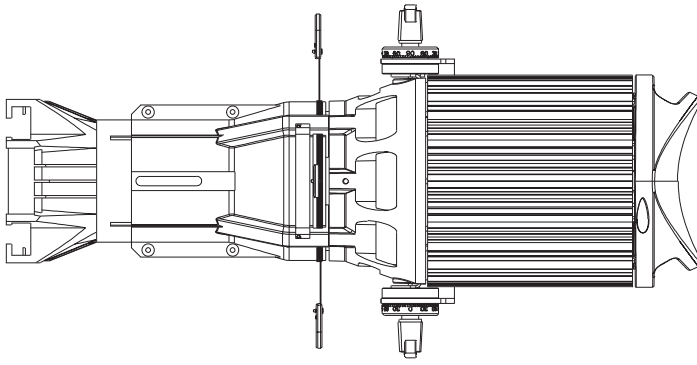

Drawing Size - Power Supply Box

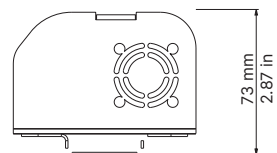
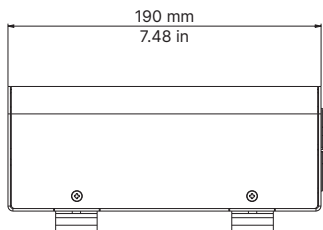
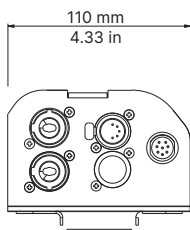

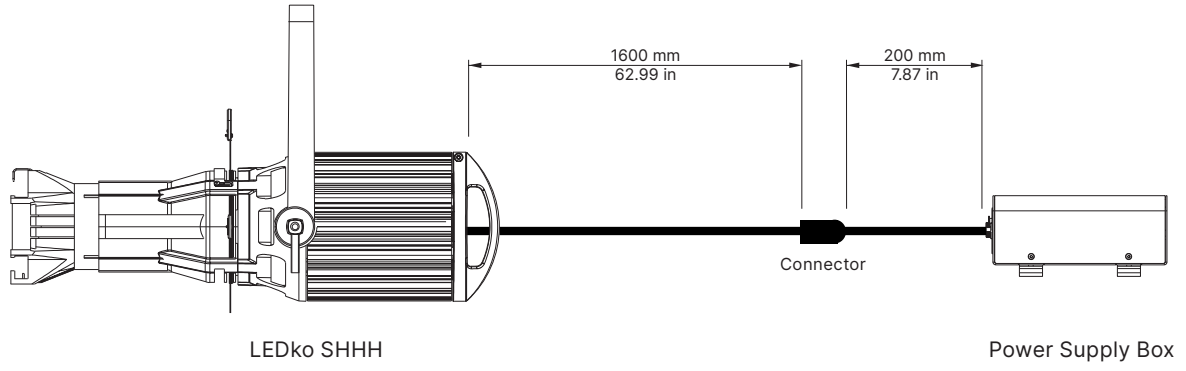



Theatre - Elbphilharmonie Und Laeiszhalle, Hamburg - Germany

Product	LEDko SHHH T Studio
CCT	3.200 K
CRI	> 95

LEDko SHHH T Studio (CRI > 95) - Lens Tubes

Optic: Lens Tube 14°

Distance(m)	3	6	9	12	15	18	21	24	27	30	
lux	3.200K	33144	8286	3683	2072	1326	921	676	518	409	331
Diameter Ø (m)	0.74	1.47	2.21	2.95	3.68	4.42	5.16	5.89	6.63	7.37	
lux	3.200K	CRI 97.3	TLCI 97								

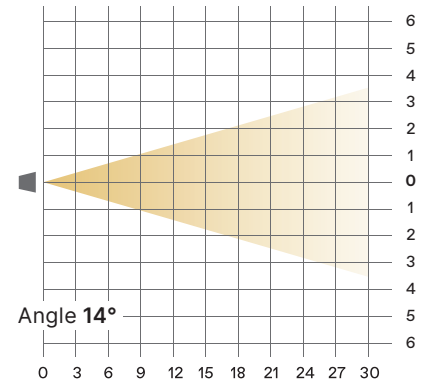

Optic: Lens Tube 19°

Distance(m)	3	6	9	12	15	18	21	24	27	30	
lux	3.200K	19.040	4760	2116	1190	762	529	389	298	235	190
Diameter Ø (m)	1,00	2,01	3,01	4,02	5,02	6,02	7,03	8,03	9,04	10,04	
lux	3.200K	CRI 97.2	TLCI 98								

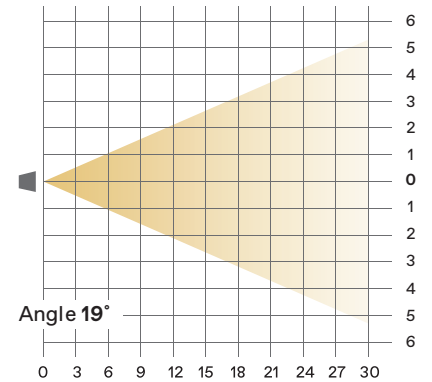

Optic: Lens Tube 26°

Distance(m)	1	2	3	4	5	6	7	8	9	10	
lux	3.200K	92.520	23.130	10.280	5.783	3.701	2.570	1.888	1.446	1.142	925
Diameter Ø (m)	0,46	0,92	1,39	1,85	2,31	2,77	3,23	3,69	4,16	4,62	
lux	3.200K	CRI 97.2	TLCI 97								

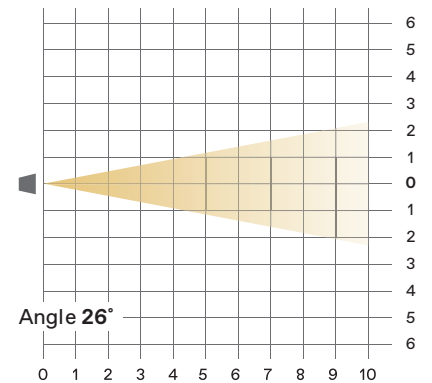

Optic: Lens Tube 36°

Distance(m)	1	2	3	4	5	6	7	8	9	10	
lux	3.200K	46.800	11.700	5.200	2.925	1.872	1.300	955	731	578	468
Diameter Ø (m)	0,65	1,30	1,95	2,60	3,25	3,90	4,55	5,20	5,85	6,50	
lux	3.200K	CRI 97.2	TLCI 98								

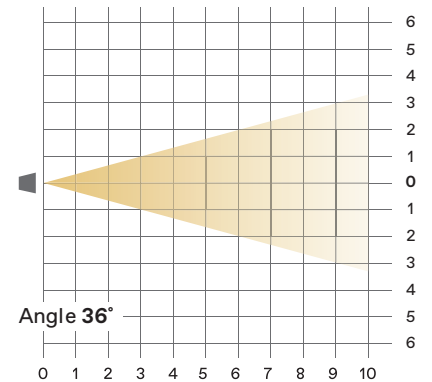

LEDko SHHH T Studio (CRI > 95) - Profile Zoom 15°-35°

Optic: **Zoom Minimum**

Distance(m)	1	2	3	4	5	6	7	8	9	10	
lux	3.200K	344403	86101	38267	21525	13776	9567	7029	5381	4252	3444
Diameter Ø (m)	0,27	0,53	0,80	1,07	1,33	1,60	1,87	2,13	2,40	2,67	
lux	3.200K	CRI96.4	TLCI 98.1								

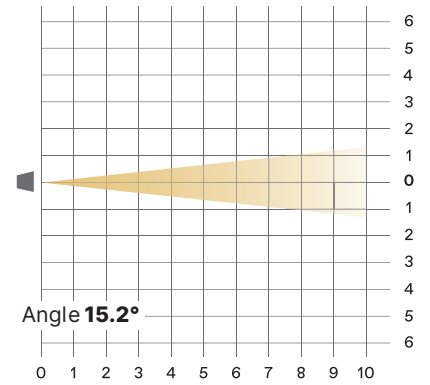

Optic: **Zoom Maximum**

Distance(m)	1	2	3	4	5	6	7	8	9	10	
lux	3.200K	141489	35372	15721	8843	5660	3930	2888	2211	1747	1415
Diameter Ø (m)	0,54	1,08	1,61	2,15	2,69	3,23	3,76	4,30	4,84	5,38	
lux	3.200K	CRI96.3	TLCI 98.2								

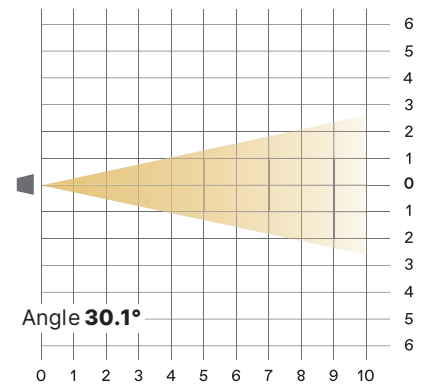

LEDko SHHH T Studio (CRI > 95) - Profile Zoom 25°-50°

Optic: **Zoom Minimum**

Distance(m)	1	2	3	4	5	6	7	8	9	10	
lux	3.200K	280035	70009	31115	17502	11201	779	5715	4376	3457	2800
Diameter Ø (m)	0.40	0.81	1.21	1.61	2.02	2.42	2.82	3.23	3.63	4.03	
lux	3.200K	CRI95.4	TLCI 97.1								

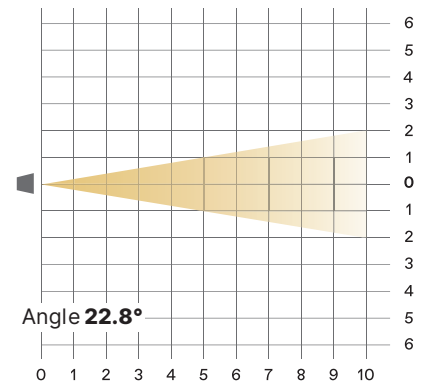

Optic: **Zoom Maximum**

Distance(m)	1	2	3	4	5	6	7	8	9	10	
lux	3.200K	61344	15336	6816	3834	2454	1704	1252	959	757	613
Diameter Ø (m)	0.96	1.92	2.87	3.83	4.79	5.75	6.71	7.67	8.62	9.58	
lux	3.200K	CRI95.3	TLCI 97.2								

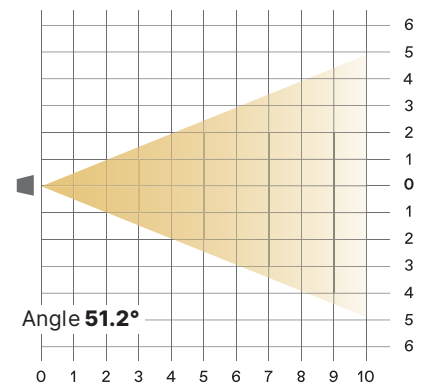

LEDko SHHH D Studio (CRI > 95) - Lens Tubes

Optic: Lens Tube 14°

Distance(m)	3	6	9	12	15	18	21	24	27	30	
lux	5.600K	35318	8830	3924	2207	1413	981	721	552	436	353
Diameter Ø (m)	0.74	1.47	2.21	2.95	3.68	4.42	5.16	5.89	6.63	7.37	
lux	5.600K	CRI 97.3	TLCI 97								

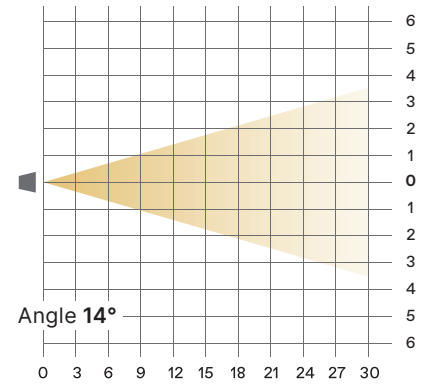

Optic: Lens Tube 19°

Distance(m)	3	6	9	12	15	18	21	24	27	30	
lux	5.600K	22780	5695	2531	1424	911	633	465	356	281	228
Diameter Ø (m)	1,00	2,01	3,01	4,02	5,02	6,02	7,03	8,03	9,04	10,04	
lux	5.600K	CRI 97.2	TLCI 98								

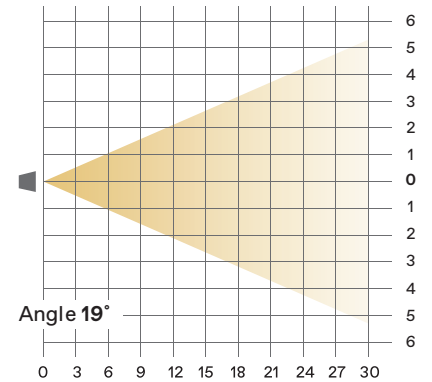

Optic: Lens Tube 26°

Distance(m)	1	2	3	4	5	6	7	8	9	10	
lux	5.600K	101920	25480	11324	6370	4077	2831	2080	1593	1258	1019
Diameter Ø (m)	0,46	0,92	1,39	1,85	2,31	2,77	3,23	3,69	4,16	4,62	
lux	5.600K	CRI 97.2	TLCI 97								

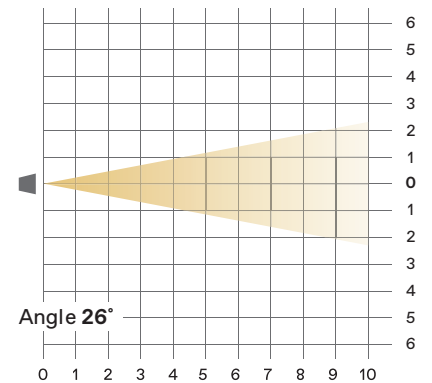

LEDko SHHH D Studio (CRI > 95) - Lens Tubes

Optic: Lens Tube 36°

Distance(m)	1	2	3	4	5	6	7	8	9	10	
lux	5.600K	52283	13071	5809	3268	2091	1452	1067	817	645	523
Diameter Ø (m)	0,65	1,30	1,95	2,60	3,25	3,90	4,55	5,20	5,85	6,50	
lux	5.600K	CRI 97.2	TLCI 98								

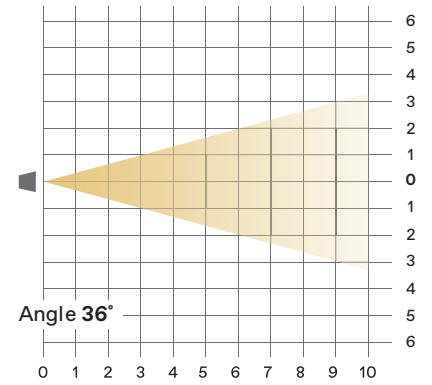

Optic: Lens Tube 50°

Distance(m)	1	2	3	4	5	6	7	8	9	10	
lux	5.600K	34153	8538	3795	3795	2135	949	697	534	422	342
Diameter Ø (m)	0.96	1.92	2.87	3.83	4.79	5.75	6.71	7.67	8.62	9.58	
lux	5.600K	CRI 97.2	TLCI 98								

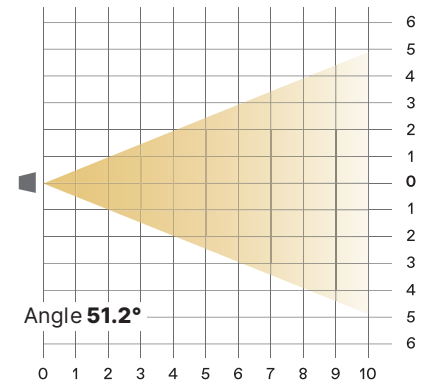

LEDko SHHH D Studio (CRI > 95) - Profile Zoom 15°-35°

Optic: **Zoom Minimum**

Distance(m)	1	2	3	4	5	6	7	8	9	10	
lux	5.600K	284837	71209	31649	17802	11393	7912	5813	4451	3517	2848
Diameter Ø (m)	0,27	0,53	0,80	1,07	1,33	1,60	1,87	2,13	2,40	2,67	
lux	5.600K	CRI96.4	TLCI 98.1								

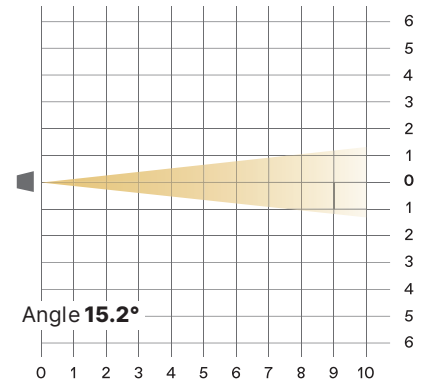

Optic: **Zoom Maximum**

Distance(m)	1	2	3	4	5	6	7	8	9	10	
lux	5.600K	83692	20923	9299	5231	3348	2325	1708	1308	1033	837
Diameter Ø (m)	0,54	1,08	1,61	2,15	2,69	3,23	3,76	4,30	4,84	5,38	
lux	5.600K	CRI96.3	TLCI 98.2								

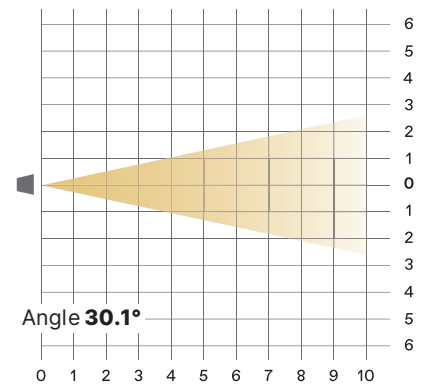

LEDko SHHH D Studio (CRI > 95) - Profile Zoom 25°-50°

Optic: **Zoom Minimum**

Distance(m)	1	2	3	4	5	6	7	8	9	10	
lux	5.600K	82957	20739	9217	5185	3318	2304	1693	1296	1024	830
Diameter Ø (m)	0.40	0.81	1.21	1.61	2.02	2.42	2.82	3.23	3.63	4.03	
lux	5.600K	CRI95.4	TLCI 97.1								

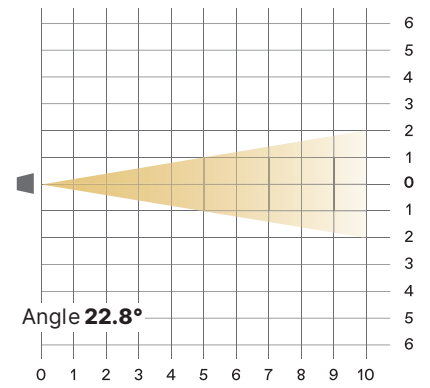

Optic: **Zoom Maximum**

Distance(m)	1	2	3	4	5	6	7	8	9	10	
lux	5.600K	44149	11037	4905	2759	1766	1226	901	690	545	441
Diameter Ø (m)	0.96	1.92	2.87	3.83	4.79	5.75	6.71	7.67	8.62	9.58	
lux	5.600K	CRI95.3	TLCI 97.2								

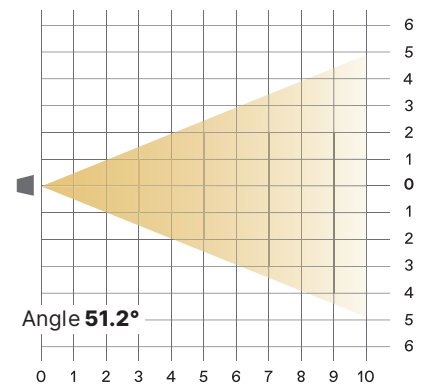

LEDko SHHH VariWhite - Lens Tubes

Optic: Lens Tube Profile 14°

Distance(m)	3	6	9	12	15	18	21	24	27	30	
lux	3.200K	35.362	8.840	3.929	2.210	1.414	982	722	553	437	354
	5.600K	41.236	10.309	4.582	2.577	1.649	1.145	842	644	509	412
Diameter Ø (m)	0,71	1,42	2,13	2,84	3,55	4,26	4,97	5,68	6,39	7,10	
lux	3.200K	CRI96.6	TLCI 98.1								
	5.600K	CRI96.8	TLCI 97.9								

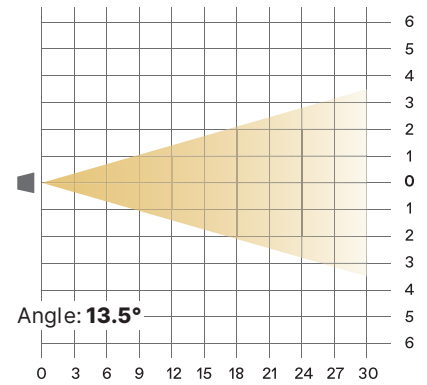

Optic: Lens Tube Profile 19°

Distance(m)	3	6	9	12	15	18	21	24	27	30	
lux	3.200K	19.801	4.950	2.200	1.238	792	550	404	309	244	198
	5.600K	23.972	5.993	2.664	1.498	959	666	489	375	296	240
Diameter Ø (m)	0,96	1,92	2,88	3,84	4,81	5,77	6,73	7,69	8,65	9,61	
lux	3.200K	CRI96.5	TLCI 98.1								
	5.600K	CRI96.6	TLCI 97.9								

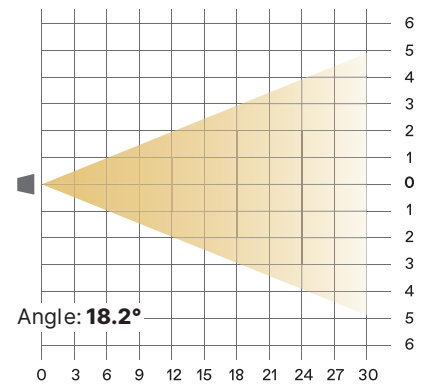

Optic: Lens Tube Profile 26°

Distance(m)	1	2	3	4	5	6	7	8	9	10	
lux	3.200K	86485	21621	9609	5405	3459	2402	1765	1351	1068	865
	5.600K	115003	28751	12778	7188	4600	3195	2347	1797	1420	1150
Diameter Ø (m)	0,45	0,91	1,36	1,82	2,27	2,73	3,18	3,63	4,09	4,54	
lux	3.200K	CRI96.1	TLCI 98.2								
	5.600K	CRI96.6	TLCI 97.9								

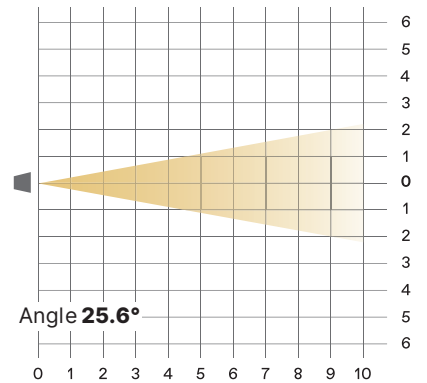

LEDko SHHH VariWhite - Lens Tubes

Optic: Lens Tube Profile 36°

Distance(m)	1	2	3	4	5	6	7	8	9	10	
lux	3.200K	49.147	12.287	5.461	3.072	1.966	1.365	1.003	768	607	491
	5.600K	59.927	14.982	6.659	3.745	2.397	1.665	1.223	936	740	599
Diameter Ø (m)	0,61	1,22	1,83	2,44	3,05	3,66	4,27	4,88	5,49	6,10	
lux	3.200K	CRI96.2	TLCI 98.1								
	5.600K	CRI96.7	TLCI 97.9								

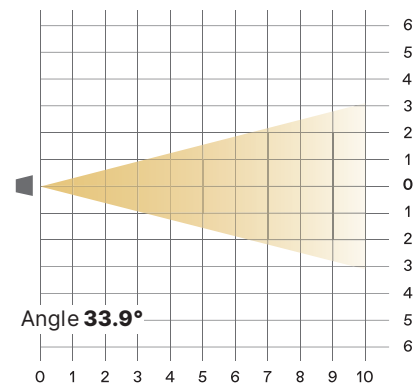

Optic: Lens Tube Profile 50°

Distance(m)	1	2	3	4	5	6	7	8	9	10	
lux	3.200K	28.665	7.166	3.185	1.792	1.147	796	585	448	354	287
	5.600K	34.741	8.685	3.860	2.171	1.390	965	709	543	429	347
Diameter Ø (m)	0,96	1,92	2,87	3,83	4,79	5,75	6,71	7,67	8,62	9,58	
lux	3.200K	CRI96.4	TLCI 98.1								
	5.600K	CRI96.7	TLCI 97.9								

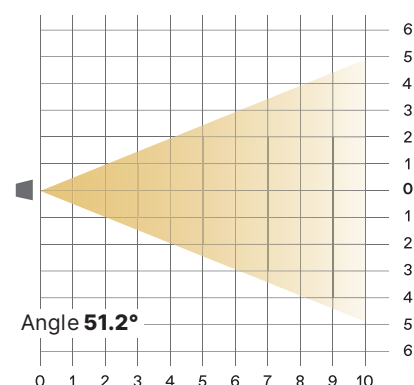

Optic: Lens Tube Profile 70°

Distance(m)	1	2	3	4	5	6	7	8	9	10	
lux	3.200K	14.342	3.586	1.594	896	574	398	293	224	177	143
	5.600K	18.855	4.714	2.095	1.178	754	524	385	295	233	189
Diameter Ø (m)	1,33	2,66	3,99	5,32	6,64	7,97	9,30	10,63	11,96	13,29	
lux	3.200K	CRI96.4	TLCI 98.2								
	5.600K	CRI96.8	TLCI 97.9								

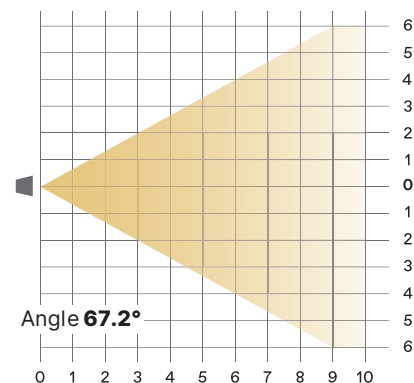

LEDko SHHH VariWhite - Profile Zoom 15°-35°

Optic: Zoom Minimum

Distance(m)	1	2	3	4	5	6	7	8	9	10	
lux	3.200K	236.229	59.057	26.248	14.764	9.449	6.562	4.821	3.691	2.916	2.362
	5.600K	287.385	71.846	31.932	17.962	11.495	7.983	5.865	4.490	3.548	2.874
Diameter Ø (m)	0,27	0,53	0,80	1,07	1,33	1,60	1,87	2,13	2,40	2,67	
lux	3.200K	CRI96.4	TLCI 98.1								
	5.600K	CRI96.5	TLCI 97.8								

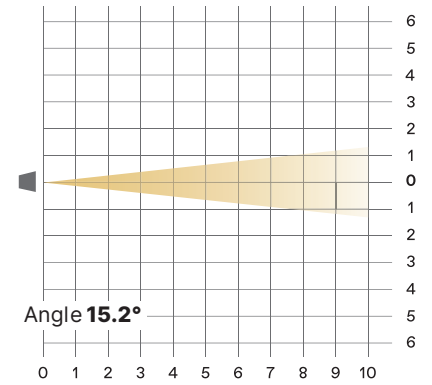

Optic: Zoom Medium

Distance(m)	1	2	3	4	5	6	7	8	9	10	
lux	3.200K	113.386	28.347	12.598	1.087	4.535	3.150	2.314	1.772	1.400	1.134
	5.600K	125.979	31.495	13.998	7.874	5.039	3.499	2.571	1.968	1.555	1.260
Diameter Ø (m)	0,40	0,81	1,21	1,61	2,02	2,42	2,82	3,23	3,63	4,03	
lux	3.200K	CRI96.4	TLCI 98.2								
	5.600K	CRI96.8	TLCI 97.6								

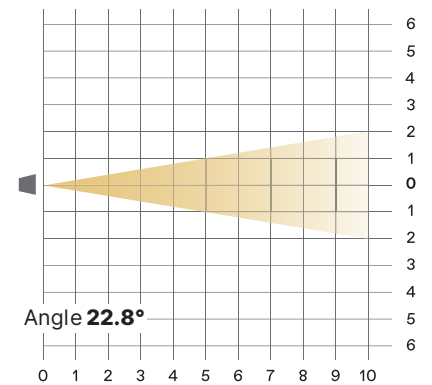

Optic: Zoom Maximum

Distance(m)	1	2	3	4	5	6	7	8	9	10	
lux	3.200K	72.177	18.044	8.020	4.511	2.887	2.005	1.473	1.128	891	722
	5.600K	87.514	21.879	9.724	5.470	3.501	2.431	1.786	1.367	1.080	875
Diameter Ø (m)	0,54	1,08	1,61	2,15	2,69	3,23	3,76	4,30	4,84	5,38	
lux	3.200K	CRI96.3	TLCI 98.1								
	5.600K	CRI96.7	TLCI 97.8								

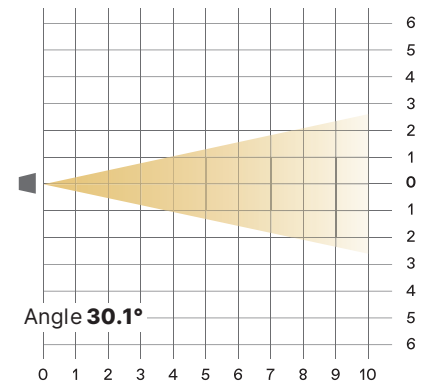

LEDko VariWhite HD + - Profile Zoom 25°-50°

Optic: Zoom Minimum

Distance(m)	1	2	3	4	5	6	7	8	9	10	
lux	3.200K	69.188	17.297	7.688	4.324	2.768	1.922	1.412	1.081	854	692
	5.600K	81.683	20.421	9.076	5.105	3.267	2.269	1.667	1.276	1.008	817
Diameter Ø (m)	0,49	0,98	1,47	1,96	2,46	2,95	3,44	3,93	4,42	4,91	
lux	3.200K	CRI96.2 TLCI 98.2									
	5.600K	CRI96.7 TLCI 97.8									

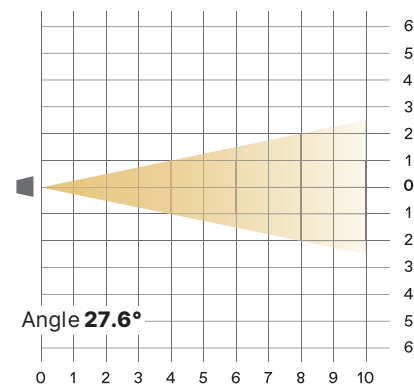

Optic: Zoom Medium

Distance(m)	1	2	3	4	5	6	7	8	9	10	
lux	3.200K	43.120	10.780	4.791	2.695	1.725	1.198	880	674	532	431
	5.600K	52.773	13.193	5.864	3.298	2.111	1.466	1.077	825	652	528
Diameter Ø (m)	0,64	1,27	1,91	2,55	3,18	3,82	4,45	5,09	5,73	6,36	
lux	3.200K	CRI95.9 TLCI 98									
	5.600K	CRI96.7 TLCI 97.7									

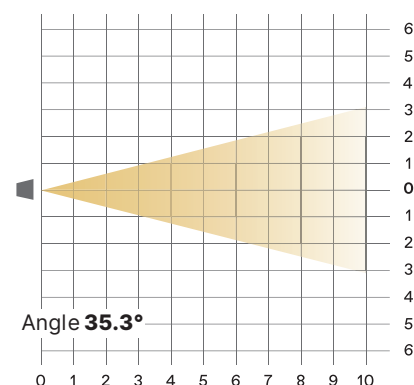

Optic: Zoom Maximum

Distance(m)	1	2	3	4	5	6	7	8	9	10	
lux	3.200K	31066	7767	3452	1942	1243	863	634	485	384	311
	5.600K	38955	9739	4328	2435	1558	1082	795	609	481	396
Diameter Ø (m)	0,78	1,56	2,35	3,13	3,91	4,69	5,47	6,25	7,04	7,82	
lux	3.200K	CRI95.8 TLCI 98.1									
	5.600K	CRI96.7 TLCI 97.7									

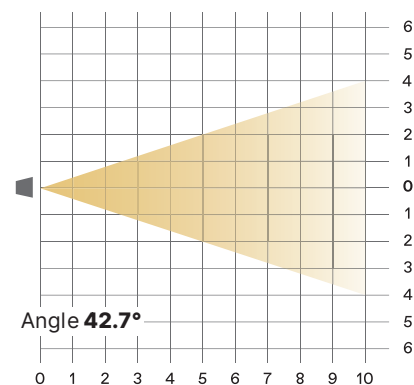

LEDko SHHH FullSpectrum - Lens Tubes

Optic: Lens Tube Profile 14°

Distance (m)		3	6	9	12	15	18	21	24	27	30
lux	RED	2033	508	226	127	81	56	41	32	25	20
	GREEN	5563	1391	618	348	223	155	114	87	69	56
	BLUE	1457	364	162	91	58	40	30	23	18	15
	CYAN	3542	886	394	221	142	98	72	55	44	35
	LIME	18001	4500	2000	1125	720	500	367	281	222	180
	AMBER	11053	2763	1228	691	442	307	226	173	136	111
	3.200 K	28899	7225	3211	1806	1156	803	590	452	357	289
	5.600 K	33548	8387	3728	2097	1342	932	685	524	414	335
Diameter Ø (m)		0.71	1.42	2.13	2.84	3.55	4.26	4.97	5.68	6.39	7.10

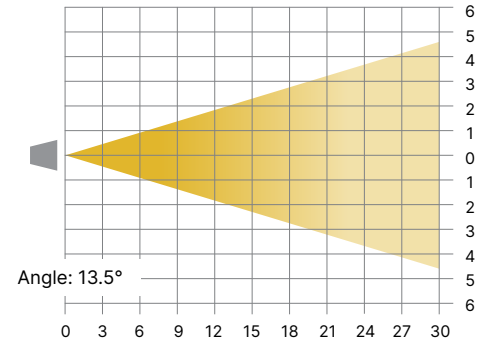

Optic: Lens Tube Profile 19°

Distance (m)		3	6	9	12	15	18	21	24	27	30
lux	RED	992	248	110	62	40	28	20	15	12	10
	GREEN	2714	678	302	170	109	75	55	42	34	27
	BLUE	711	178	79	44	28	20	15	11	9	7
	CYAN	1728	432	192	108	69	48	35	27	21	17
	LIME	8781	2195	976	549	351	244	179	137	108	88
	AMBER	5392	1348	599	337	216	150	110	84	67	54
	3.200 K	13981	3495	1553	874	559	388	285	218	173	140
	5.600 K	15956	3989	1773	997	638	443	326	249	197	160
Diameter Ø (m)		0.91	1.81	2.72	3.63	4.54	5.44	6.35	7.26	8.17	9.07

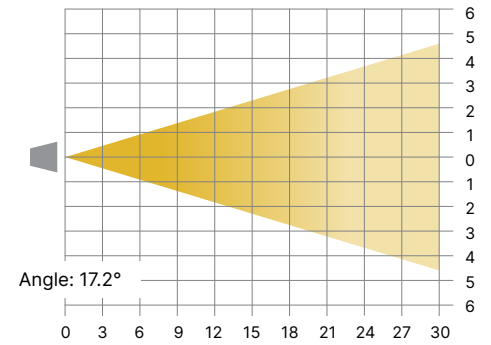

Optic: Lens Tube Profile 26°

Distance (m)		1	2	3	4	5	6	7	8	9	10
lux	RED	4800	1200	533	300	192	133	89	75	59	48
	GREEN	12850	3213	1428	803	514	357	262	201	159	129
	BLUE	3400	850	378	213	136	94	69	53	42	34
	CYAN	8225	2056	914	514	329	228	168	129	102	82
	LIME	41850	10463	4650	2616	1674	1163	854	654	517	419
	AMBER	25800	6450	2867	1613	1032	717	527	403	319	258
	3.200 K	66225	16556	7358	4139	2649	1840	1352	1035	818	662
	5.600 K	75125	18781	8347	4695	3005	2087	1533	1174	927	751
Diameter Ø (m)		0.44	0.88	1.32	1.76	2.20	2.64	3.08	3.52	3.96	4.40

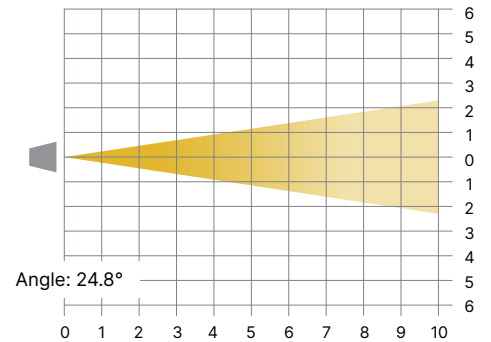

LEDko SHHH FullSpectrum - Lens Tubes

Optic: Lens Tube Profile 36°

Distance (m)		1	2	3	4	5	6	7	8	9	10
lux	RED	2400	600	267	150	96	67	49	38	30	24
	GREEN	6525	1631	725	408	261	181	133	102	81	65
	BLUE	1775	444	197	111	71	49	36	28	22	18
	CYAN	4225	1056	469	264	169	117	86	66	52	42
	LIME	21050	5263	2339	1316	842	585	430	329	260	211
	AMBER	12950	3238	1439	809	518	360	264	202	160	130
	3.200 K	33150	8288	3683	2072	1326	921	677	518	409	332
	5.600 K	37625	9406	4181	2352	1505	1045	768	588	465	376
Diameter Ø (m)		0.60	1.19	1.79	2.38	2.98	3.58	4.17	4.77	5.37	5.96

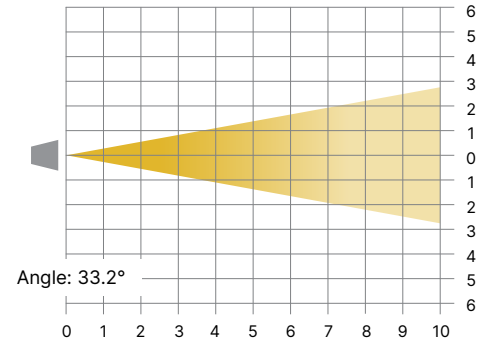

Optic: Lens Tube Profile 50°

Distance (m)		1	2	3	4	5	6	7	8	9	10
lux	RED	1368	342	152	86	55	38	28	21	17	14
	GREEN	3719	930	413	232	149	103	76	58	46	37
	BLUE	1011	253	112	63	40	28	21	16	12	10
	CYAN	2408	602	268	151	96	67	49	38	30	24
	LIME	11998	3000	1333	750	480	333	245	187	148	120
	AMBER	7381	1845	820	461	295	205	151	115	91	74
	3.200 K	18895	4724	2099	1181	756	525	386	295	233	189
	5.600 K	21446	5362	2383	1340	858	596	438	335	265	214
Diameter Ø (m)		0.95	1.91	2.86	3.82	4.77	5.72	6.68	7.63	8.59	9.54

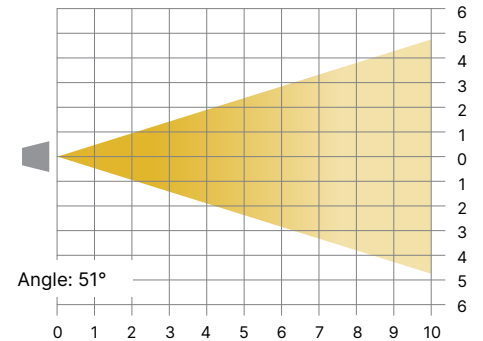

LEDko SHHH FullSpectrum - Profile Zoom 15°-35°

Optic: **Zoom Minimum**

Distance (m)		1	2	3	4	5	6	7	8	9	10
lux	RED	5544	1386	616	347	222	154	113	87	68	55
	GREEN	16214	4054	1802	1013	649	450	331	253	200	162
	BLUE	4072	1018	452	255	163	113	83	64	50	41
	CYAN	9167	2292	1019	573	367	255	187	143	113	92
	LIME	50180	12545	5576	3136	2007	1394	1027	784	620	502
	AMBER	32456	8114	3606	2029	1298	902	662	507	401	325
	3.200 K	41628	10407	4625	2602	1665	1156	850	650	514	416
	5.600 K	90868	22717	10096	5679	3635	2524	1854	1420	1122	909
Diameter Ø (m)		0.27	0.53	0.80	1.07	1.33	1.60	1.87	2.13	2.40	2.67

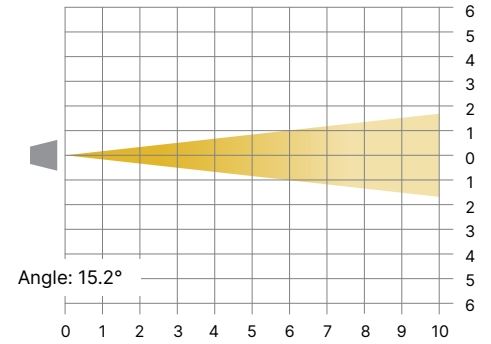

Optic: **Zoom Maximum**

Distance (m)		1	2	3	4	5	6	7	8	9	10
lux	RED	1958	490	218	122	78	54	40	31	24	20
	GREEN	5524	1381	614	345	221	153	113	86	68	55
	BLUE	1382	346	154	86	55	38	28	22	17	14
	CYAN	3105	776	345	194	124	86	63	49	38	31
	LIME	17150	4288	1906	1072	686	476	350	268	212	172
	AMBER	11159	2790	1240	697	446	310	228	174	138	112
	3.200 K	28164	7041	3129	1760	1127	782	575	440	348	282
	5.600 K	31802	7951	3534	1988	1272	883	649	497	393	318
Diameter Ø (m)		0.55	1.11	1.66	2.22	2.77	3.33	3.88	4.44	4.99	5.55

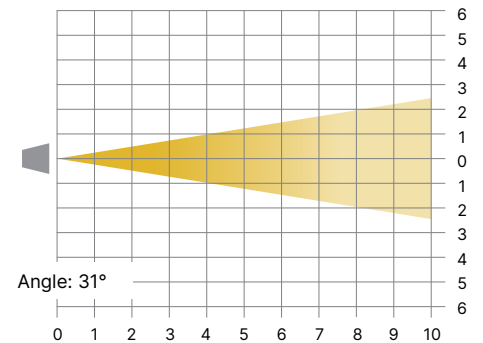

LEDko SHHH FullSpectrum - Profile Zoom 25°-50°

Optic: **Zoom Minimum**

Distance (m)		1	2	3	4	5	6	7	8	9	10
lux	RED	3456	864	384	216	138	96	71	54	43	35
	GREEN	10453	2613	1161	653	418	290	213	163	129	105
	BLUE	2622	656	291	164	105	73	54	41	32	26
	CYAN	5959	1490	662	372	238	166	122	93	74	60
	LIME	31847	7962	3539	1990	1274	885	650	498	393	318
	AMBER	20421	5105	2269	1276	817	567	417	319	252	204
	3.200 K	51342	12835	5705	3209	2054	1426	1048	802	634	513
	5.600 K	58297	14574	6477	3644	2332	1619	1190	911	720	583
<hr/>											
Diameter Ø (m)		0.40	0.81	1.21	1.61	2.02	2.42	2.82	3.23	3.63	4.03

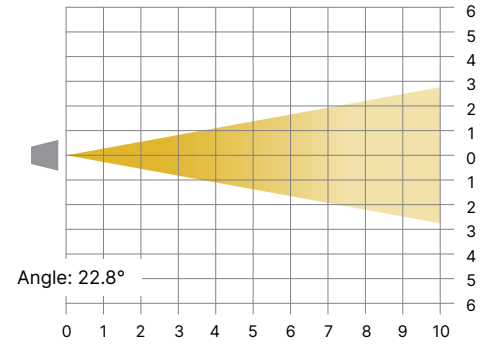

Optic: **Zoom Maximum**

Distance (m)		1	2	3	4	5	6	7	8	9	10
lux	RED	920	230	102	58	37	26	19	14	11	9
	GREEN	2769	692	308	173	111	77	57	43	34	28
	BLUE	652	163	72	41	26	18	13	10	8	7
	CYAN	1535	384	171	96	61	43	31	24	19	15
	LIME	8385	2096	932	524	335	233	171	131	104	84
	AMBER	5407	1352	601	338	216	150	110	84	67	54
	3.200 K	13879	3470	1542	867	555	386	283	217	171	139
	5.600 K	15674	3919	1742	980	627	435	320	245	194	157
<hr/>											
Diameter Ø (m)		0.96	1.92	2.87	3.83	4.79	5.75	6.71	7.67	8.62	9.58

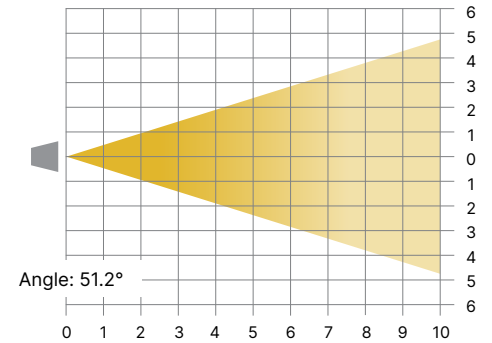

● Coemar Lighting S.r.l.

Via Carpenedolo, 90
46043, Castiglione delle Stiviere (MN) – Italy

P. +39 0376 1514412

M1. info@coemar.com

M2. service@coemar.com

W. coemar.com

P.iva – C.f. 02415330204

